



Innovation in every connection.

Single Phase Distribution Issue 3

Elucian® Single Phase solutions. An extensive range of consumer units and protection devices, packed with advanced features for safety, flexibility, and reliability.



Elucian® by Click® brings to market a comprehensive Consumer Unit and Circuit Protection range.



Get to know us



Designed with installers in mind

Through close collaboration with contractors and installers, our product range has been tailored to meet industry needs while ensuring full compliance with the latest regulations.

Designed with the installer in mind, Elucian® is an extensive range of metal consumer units that covers a broad range of installations and offers a number of features and benefits that will enhance the products' convenience, flexibility and safety properties.

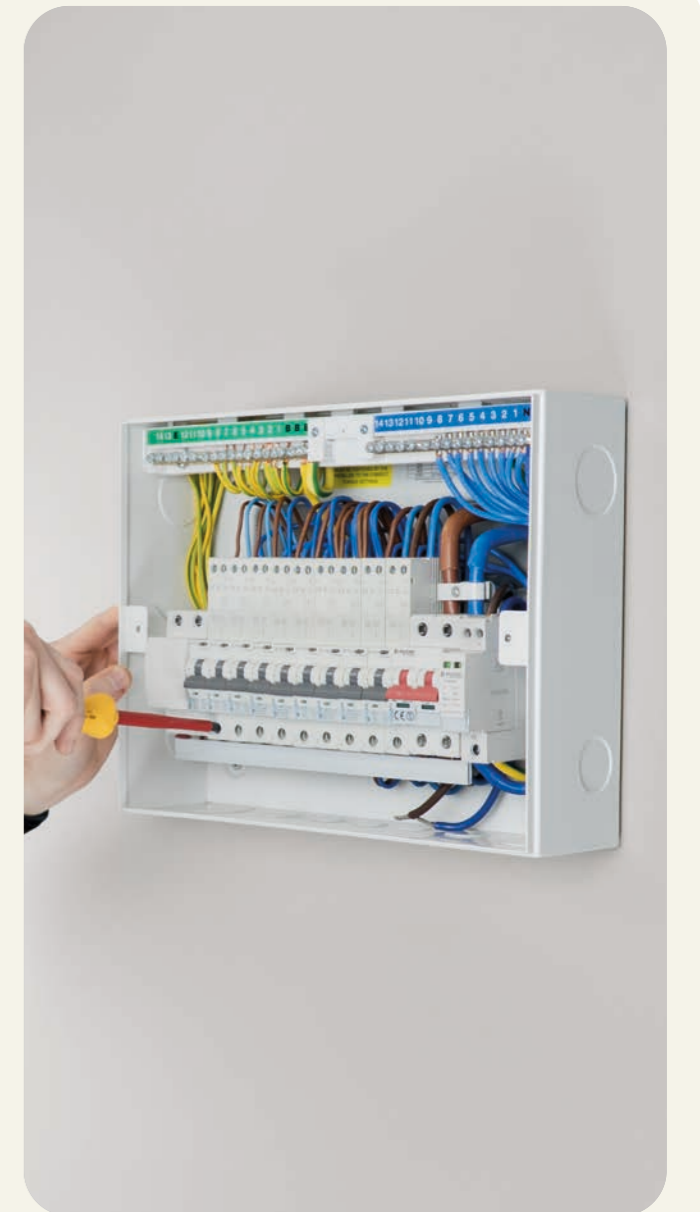

Reliable Consumer Units & Circuit Protection for safe and easy installations.



Precision manufacturing for reliability and safety.

Safety First 

At Elucian®, precision manufacturing is at the core of our commitment to reliability and safety. Our Three Phase Distribution Boards are meticulously designed and engineered to deliver consistent, high-performance results, making them a trusted choice for professionals. Each board undergoes rigorous testing to meet and exceed BS EN 61439-3 standards, ensuring compliance with safety, durability, and functionality requirements. This thorough process guarantees that our products provide dependable, long-lasting solutions for even the most demanding electrical installations, offering peace of mind to installers and end-users alike.

Unbeatable Quality 

Uncompromising quality you can trust.

Elucian® products are crafted with a commitment to exceptional quality. We use only the finest materials and subject every product to rigorous testing to ensure they meet and exceed industry standards. This dedication to excellence guarantees reliable, durable, and safe solutions for all your electrical installations.



Endless Support 

Technical support when you need it.

Our in-house Scolmore® Group technical support team is here to assist with all your Three Phase queries, offering expert advice and guidance. For additional information and support, visit our website to access helpful resources and solutions.



The Elucian® consumer units range has been designed to ensure compliance with BS 7671.

Our engineers have considered how installers need to comply with the UK wiring regulations when installing consumer units in properties across the UK. The Elucian® range has comprehensive options for every installation. These consist of Main Switch units, RCBO units, Split Load units and our Combination units.

Explore Three Phase

Explore our full range of Three Phase Distribution Boards, Circuit Protection Devices and accessories.

Three Phase on [Page 79](#)



Overload Protection

(536.4.3.2) & (536.4.202)

RCCBs are not designed to be able to withstand overload current. Care should be given when assessing the likely loading of the final circuits.

The designer and installer must therefore select the correct rated device from the options we have made available; 63A, 80A or 100A. To make this process easier we have installed 80A devices as standard.

Types of RCD

(531.3.3)

Many different types of RCD exist. BS 7671 recognises Types AC, A, F and B. Currently AC RCDs are recognised as acceptable for general purpose. However, if the installation has any DC components or frequency alterations due to connected loads one of the other types must be selected.

As most installations in the UK now have some DC components, Type A RCDs are the basic type of device selected for use.

Where higher frequencies exist, or where larger DC components exist, Type F or Type B RCDs should be selected for use. Furthermore, there are several specific requirements in BS 7671 where either Type F or Type B devices are necessary.

Over-voltage Protection

(Section 443) & (Section 534)

SPDs offer very effective protection against over-voltage. Section 443 covers the requirements for consideration when selecting SPDs in the electrical system.

Section 534 confirms what SPDs are required and where they must be installed within the electrical system.

We have designed our SPD consumer unit to incorporate a type 2 device. These devices offer protection from man-made over-voltages or lightning strokes within the vicinity of the installation.

Having SPDs installed adjacent to the main switch allows for compliance with the maximum length of cable

Division of Installation

(Section 314)

This regulation set requires the designer and installer to ensure the installation is divided up as necessary to:

- (i) Avoid danger and minimise inconvenience in the event of a fault.
- (ii) Facilitate safe inspection, testing & maintenance.
- (iii) Take account of hazards that may arise from the failure of a single circuit.
- (iv) Reduce the possibility of unwanted tripping of RCDs due to excessive protective conductor current or due to fault.
- (v) Mitigate the effects of electromagnetic disturbances.
- (vi) Prevent the indirect energization of a circuit intended to be isolated.



New arrivals in this issue.

Premium Lockable Enclosure Covers

Provides secure, tamper resistant protection while allowing easy, controlled access for maintenance and upgrades.



Energy Meters

Delivering trusted performance in a smaller form, our latest meters make energy monitoring smarter, faster, and easier.



EV Boards

Our latest EV boards combine safety, flexibility, and durability, with select IP65-rated models built for demanding installations.

Available in White & Anthracite Grey.



Populated Boards

Ready-populated and configurable, these boards deliver efficiency and reliability for both standard and extensive setups.

Available in a wide range of sizes, from 5-way to 44-way.



Overload protection of RCCBs...

These devices may be overloaded if the combined outgoing current from the final circuits is greater than the rating of the RCCB. Therefore, we provide an 80A device as standard with the ability to change this to a 100A, or reduce to a 63A if required.

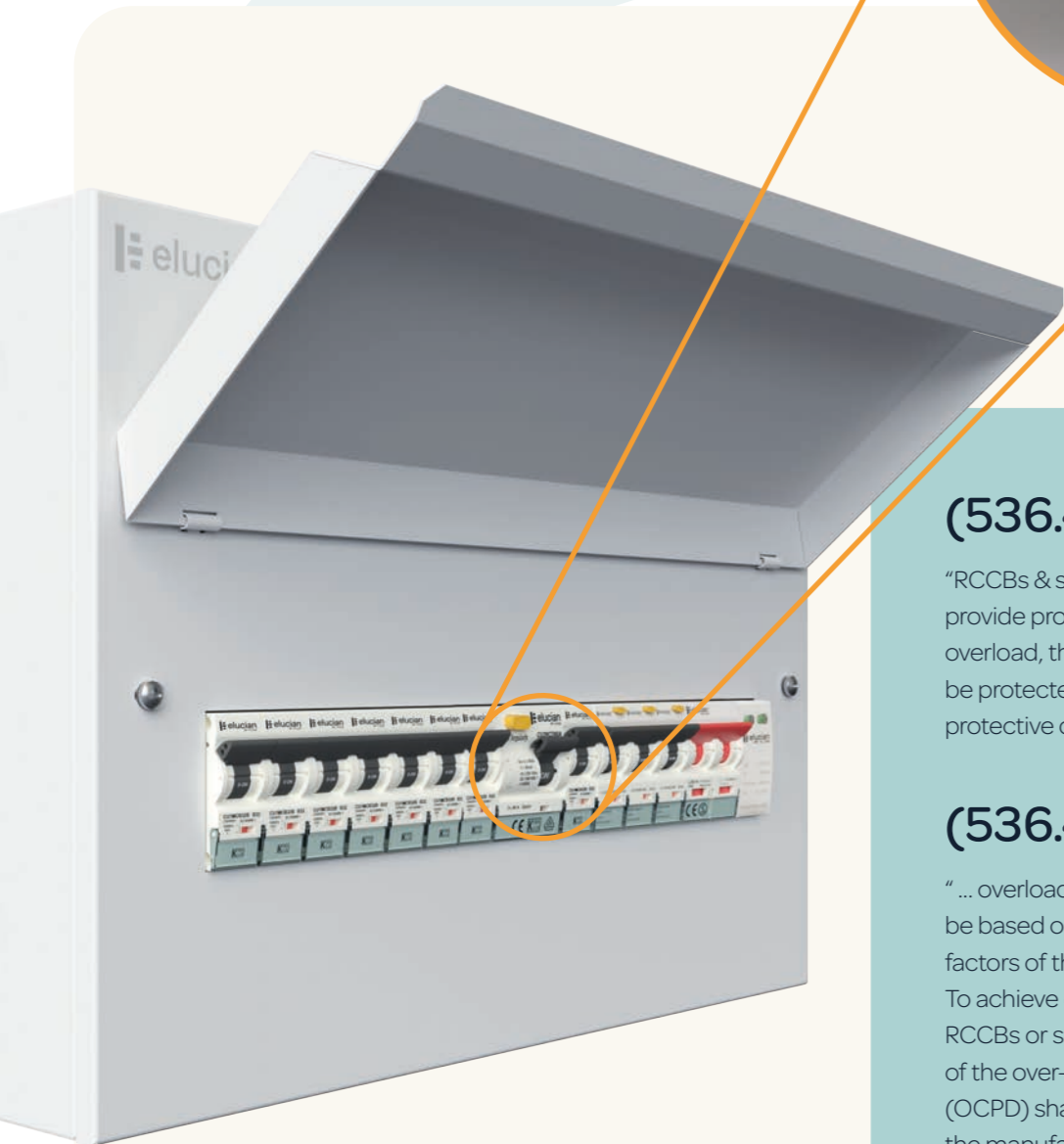

(536.4.3.2)

“RCCBs & switches do not provide protection against overload, therefore they shall be protected by an overcurrent protective device.”

(536.4.202)

“... overload protection shall not solely be based on the use of diversity factors of the downstream circuits. To achieve overload protection of RCCBs or switches, the rated current of the over-current protective device (OCPD) shall be selected according to the manufacturers instructions”.

Comply with the regulations...

Regulations 536.4.3.2 and 536.4.202 require the designer to understand the loading profile of the RCCBs within the consumer unit. RCCBs will protect a number of outgoing circuits at the same time.

Method 1

Ensure the full load of all final circuits being protected are less than the rating of the RCCB. The installer will need to consider diversity for the final circuits, but not use diversity as the sole factor for calculating the total current downstream of the device.

Method 2

Ensure the main protective device is of a size to limit the total amount of amps upstream of the devices.

Example 1:

This install would not comply. RCCB1 could be subject to overload.

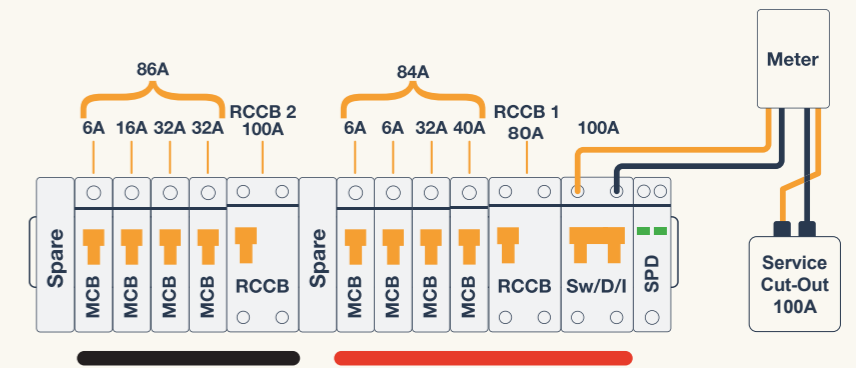

Example 2:

This installation would comply. Although RCCB1 could potentially become overloaded, the protective device at the origin would offer overload protection.

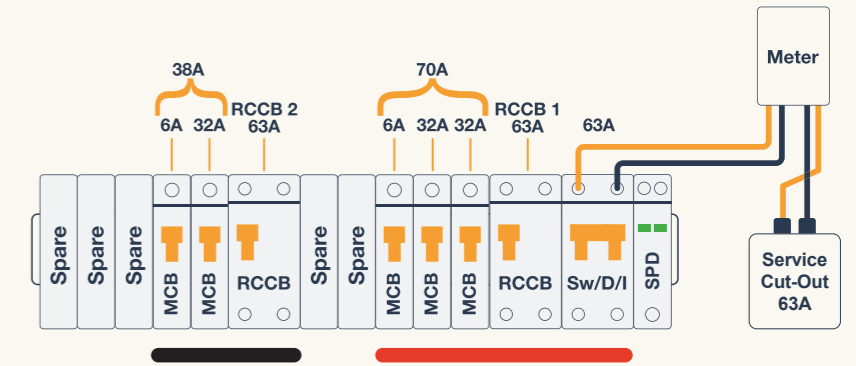

Example 3:

RCBOs offer comprehensive protection as each device is rated to the circuit.

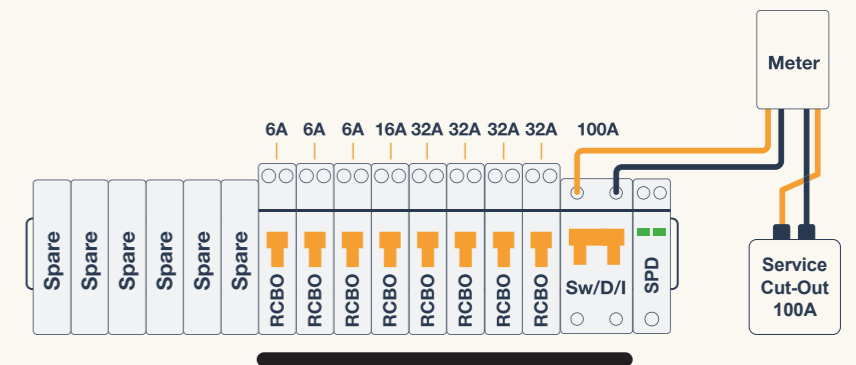

RCCB & RCBO Protection Devices...

RCCBs are available in a number of common types; AC, A, F or B. Dependant on the characteristics of the final circuit/s being controlled, the type of RCCB selected is very important. If it is believed DC current could be present in the protected circuit/s due to the equipment connected, the designer should select a device capable of working with that DC current present.

General RCCBs are designed to operate instantaneously without intentional delay; because of this they are not designed to discriminate in the event of a fault. Therefore, if two general RCCBs were to be installed in series, both may operate when a fault presents itself. To avoid this, selectivity is essential between the installed devices to reduce the unintentional operation of a device upstream from the leakage to Earth.

Installing the correct type of device is essential if it is believed DC current could be present within the installation. It is important to install an RCD type that is capable of handling DC current ahead of a device that isn't able to operate with these currents.

Such as:

kWh	C/U with Type AC RCCB	Mini C/U with Type A RCCB	●
kWh	C/U with Type A RCCB	Mini C/U with Type A RCCB	●
kWh	C/U with Type A RCCB	Mini C/U with Type B RCCB	●
kWh	C/U with Type B RCCB	Mini C/U with Type A RCCB	●



Type A RCCB

In today's installations the majority of equipment does have some residual DC current due to the internal electronics. The magnitude of this current can have a detrimental effect on the effectiveness of the protective device.

Type A devices have the ability to continue to work with up to 6mA of DC fault current present. This amount of fault current has been shown to stop AC Type RCCBs/RCBOs from working within the maximum time permitted in BS7671.

RCCB - Residual Current Operated Circuit Breaker, without integrated overcurrent protection.

Full listings **Page 60**



RCBO Protection

These devices combine the functionality of an MCB and RCCB into one single device/module. Available as a Type A RCD with different inrush curve types B or C, these protection devices have been miniaturised to maximise the available space above for termination or final circuits.

The Neutral fly lead has been made long enough to ensure safe connection to the dedicated Neutral bars.

RCBO - Residual Current Operated Circuit Breaker, with integrated overcurrent protection.

Full listings **Page 61-64**



Safeguard your installations with Surge Protection.

I_{imp} - Impulse current of 10/350 μ s waveform.

I_n - Surge current of 8/20 μ s waveform associated with Type 2 SPDs.

U_p - The residual voltage that is measured across the terminal of the SPD when I_n is applied.

U_c - The maximum voltage which may be continuously applied to the SPD without it conducting.

I_{max} - Maximum short circuit current of the device.

Full listings **Page 59**



Transient Over-voltages

Many installations across the UK have electronic components within them. Surge protection will offer those devices and appliances protection from over-voltage.

Products such as computers, printers, flat screen televisions, alarms, microwaves and washing machines are commonplace. These can all be vulnerable to transient over voltages, which can significantly reduce the equipment's lifespan through degradation and damage.

A transient over voltage or surge is a short duration increase in voltage measured between two or more conductors. In short, this means anything from microseconds (millionths of a second) to a few milliseconds (thousandths of a second) in duration.

Covers Overvoltage Control (443.4.1 & 443.4.2)

Protection against overvoltages shall be provided where the consequence caused by overvoltage could:

- (i) Result in serious injury to, or loss of, human life,
- (ii) Result in significant financial loss or data loss

For all other cases, protection against transient overvoltages shall be provided unless the owner of the installation declares it is not required due to any loss or damage being tolerable and they accept the risk of damage to equipment and any consequential loss.

Protection against overvoltages shall be considered in the case of equipment likely to produce switching overvoltages or disturbances exceeding the values according to the voltage category of the installation, e.g. where an LV generator supplies the installation or where inductive or capacitive loads (e.g. motors, transformers, capacitor banks) storage units or high-current loads are installed.



SPD Type 2

SPD which can prevent the spread of over-voltages in the electrical installations and protects equipment connected to it. It usually employs metal oxide varistor (MOV) technology and is characterised by an 8/20 μ s current wave.

SPD listing **Page 59**



Functional, stylish,
and innovative.

Consumer Units

Our Elucian® range of consumer units provides an exceptional option for any residential or light commercial environment. Packed with features making installation quick and simple for electricians, with a clear labelling kit for easy identification for the customer. A great range of configurations and sizes makes Elucian® perfect for any installation requirement.

Features & Benefits



Metal Consumer Units

All Elucian® consumer units are constructed using non-combustible and robust metal housings. They ensure compliance against the third amendment which was added to the BS 7671 wiring regulations in 2015 requiring consumer units in domestic premises to have a non-combustible enclosure.



Mains Switch Tail Clamp

Each consumer and mini unit come supplied and pre-fitted with a Mains Switch Tail Clamp for added stress relief to ensure the Mains Tail terminations do not come loose and to help fix the Mains Switch Isolator more securely to prevent any rocking or movement. The Mains Switch Tail Clamp will accept a maximum of 25mm² double insulated tails.

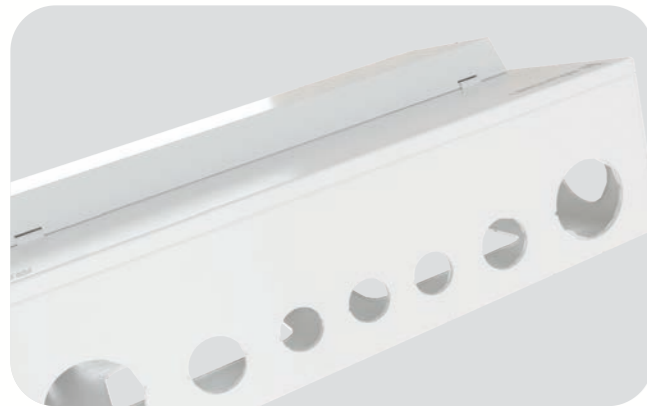

Variable Knockout Sizes

The units all come supplied with a wide range of 40mm, 32mm, 25mm and 20mm knockouts making each board universally adaptable for all installation and cable types.



Rear Knockouts

The units also come supplied with rear knockouts to provide ample cabling capacity for any installation type. Each knockout will be supplied with a 0.5M grommet strip to allow a smooth entry into the board, protecting cable from any potential sharp edges.



Shrouded Live Busbar

Our live busbar comes supplied with the shroud pre-fitted for extra safety and convenience. Our Neutral and Earth Busbars are supplied with backed off screws allowing a faster installation.



Accessories Pack

Contains a Sticker Set for clear circuit identification and caution warnings, Grommet Knockout Strips, 2 x Blank Modules, a detailed instruction sheet for all recommended installation details and a Live Busbar, Cover and Caps for added insulation and installation completion.

Take a look inside our Single Phase Boards.



1 Non-Combustible Enclosures

Non-combustible and robust metal housings ensure compliance against the third amendment added to the BS 7671 wiring regulations.

3 Earth and Neutral Bar

Each unit has its own specifically configured Earth and Neutral Bar to allow for best practice installation of each board type.

5 Large Space for Wiring

Each consumer unit has a large space for wiring, suitable for the increasing demands and circuit ways on a consumer unit.

7 MCB Style Solid Blanks

These are DIN Rail mountable and can only be removed when the cover is removed, thus providing additional safety. Other types of blanks can easily fall out or become dislodged.

9 Lock Off Capabilities

Lockout devices are designed to attach to the moving part of the protective device, usually a switch toggle (rocker switch) which moves from the on to off position.

2 Torque Rating Label

There is a handy Torque rating label inside every consumer unit, allowing you to make all terminations with ease.

4 Grommet Strip

Each knockout will be supplied with a 0.5m grommet strip to allow a smooth entry into the board, protecting cable from any potential sharp edges.

6 Keyway DIN Rail

A fast release Keyway DIN Rail allows for ease of installation.

8 Enhanced Protection with AFDDs with integrated RCBO

The smart way to detect arc faults in your circuits.

10 Compact RCBOs (not shown)

The latest design in compact RCBOs leaves more than sufficient space for cabling and terminating.

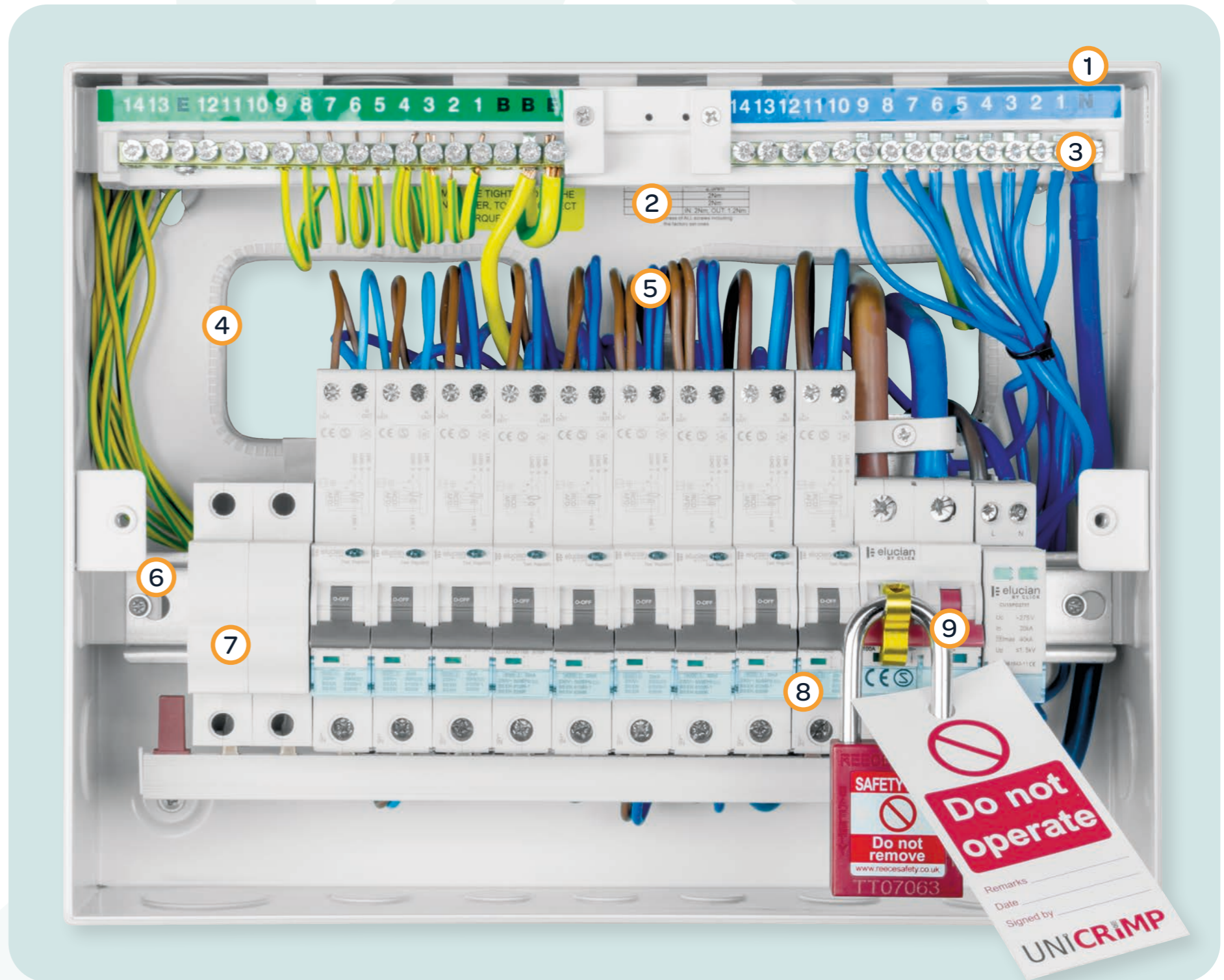



Unpopulated Consumer Units

A range of unpopulated Elucian® Metal Consumer Units ideal for those projects that need custom configuration without limitations on module placement.



Tail Clamp
Pre-Installed



*Example shown - CUEB16

Terminal Layouts...

5 Way - Neutral & Earth Terminal Configuration



6 Way - Neutral & Earth Terminal Configuration



8 Way - Neutral & Earth Terminal Configuration



10 Way - Neutral & Earth Terminal Configuration



12 Way - Neutral & Earth Terminal Configuration



14 Way - Neutral & Earth Terminal Configuration



16 Way - Neutral & Earth Terminal Configuration



18 Way - Neutral & Earth Terminal Configuration



22 Way - Neutral & Earth Terminal Configuration



Product SKU	Description	Dimensions (mm)
GUEB5	5 Way Unpopulated Metal Garage Unit	168 (W) x 260 (H) x 115 (D)
CUEB6	6 Way Unpopulated Metal Consumer Unit	185 (W) x 260 (H) x 115 (D)
CUEB8	8 Way Unpopulated Metal Consumer Unit	222 (W) x 260 (H) x 115 (D)
CUEB10	10 Way Unpopulated Metal Consumer Unit	258 (W) x 260 (H) x 115 (D)
CUEB12	12 Way Unpopulated Metal Consumer Unit	294 (W) x 260 (H) x 115 (D)
CUEB14	14 Way Unpopulated Metal Consumer Unit	330 (W) x 260 (H) x 115 (D)
CUEB16	16 Way Unpopulated Metal Consumer Unit	366 (W) x 260 (H) x 115 (D)
CUEB18	18 Way Unpopulated Metal Consumer Unit	402 (W) x 260 (H) x 115 (D)
CUEB22	22 Way Unpopulated Metal Consumer Unit	474 (W) x 260 (H) x 115 (D)



Switch-Disconnecter Units

A range of Elucian® Metal Consumer Units furnished with a 100A Mains Switch.



Straight Mains Board



100A Mains Switch Fitted



Tail Clamp Pre-Installed



*Example shown - CUEB12MS10

Terminal Layouts...

8 Way - Neutral & Earth Terminal Configuration



10 Way - Neutral & Earth Terminal Configuration



12 Way - Neutral & Earth Terminal Configuration



14 Way - Neutral & Earth Terminal Configuration



16 Way - Neutral & Earth Terminal Configuration



18 Way - Neutral & Earth Terminal Configuration



22 Way - Neutral & Earth Terminal Configuration



Product SKU	Description	Dimensions (mm)
CUEB6MS4	6 Way Unit with 100A Mains Switch (4 Free Ways)	185 (W) x 260 (H) x 115 (D)
CUEB8MS6	8 Way Unit with 100A Mains Switch (6 Free Ways)	222 (W) x 260 (H) x 115 (D)
CUEB10MS8	10 Way Unit with 100A Mains Switch (8 Free Ways)	258 (W) x 260 (H) x 115 (D)
CUEB12MS10	12 Way Unit with 100A Mains Switch (10 Free Ways)	294 (W) x 260 (H) x 115 (D)
CUEB14MS12	14 Way Unit with 100A Mains Switch (12 Free Ways)	330 (W) x 260 (H) x 115 (D)
CUEB16MS14	16 Way Unit with 100A Mains Switch (14 Free Ways)	366 (W) x 260 (H) x 115 (D)
CUEB18MS16	18 Way Unit with 100A Mains Switch (16 Free Ways)	402 (W) x 260 (H) x 115 (D)
CUEB22MS20	22 Way Unit with 100A Mains Switch (20 Free Ways)	474 (W) x 260 (H) x 115 (D)



Switch-Disconnecter Units Including Surge Protection

A range of Elucian® Metal Consumer Units furnished with a 100A Mains Switch and a 2 Pole Type 2 275Uc (V-) 40kA SPD.



Straight Mains Board



100A Mains Switch Fitted



Tail Clamp Pre-Installed



SPD Fitted



*Example shown - CUEB18MSSP15

Terminal Layouts...

10 Way - Neutral & Earth Terminal Configuration



12 Way - Neutral & Earth Terminal Configuration



14 Way - Neutral & Earth Terminal Configuration



16 Way - Neutral & Earth Terminal Configuration



18 Way - Neutral & Earth Terminal Configuration



22 Way - Neutral & Earth Terminal Configuration



Product SKU	Description	Dimensions (mm)
CUEB10MSSP7	10 Way Unit with 100A Mains Switch & SPD (7 Free Ways)	258 (W) x 260 (H) x 115 (D)
CUEB12MSSP9	12 Way Unit with 100A Mains Switch & SPD (9 Free Ways)	294 (W) x 260 (H) x 115 (D)
CUEB14MSSP11	14 Way Unit with 100A Mains Switch & SPD (11 Free Ways)	330 (W) x 260 (H) x 115 (D)
CUEB16MSSP13	16 Way Unit with 100A Mains Switch & SPD (13 Free Ways)	366 (W) x 260 (H) x 115 (D)
CUEB18MSSP15	18 Way Unit with 100A Mains Switch & SPD (15 Free Ways)	402 (W) x 260 (H) x 115 (D)
CUEB22MSSP19	22 Way Unit with 100A Mains Switch & SPD (19 Free Ways)	474 (W) x 260 (H) x 115 (D)



REC Unit

A range of Elucian® Metal REC Units furnished with a 100A Mains Switch and a 2 Pole Type 2 275Uc (V-) 40kA SPD.

100A

Mains
Switch Fitted



Tail Clamp
Pre-Installed

SPD

SPD Fitted



Terminal Layouts...

3 Way - Neutral & Earth Terminal Configuration



Product SKU	Description	Dimensions (mm)
RECEB3MSSP	3 Way Metal REC Unit with 100A Main Switch & SPD	110 (W) x 260 (H) x 115 (D)



Split Load Units

A range of Elucian® Metal Consumer Units furnished with a 100A Mains Switch and 2 x 80A Type A RCCBs.



Split Load Board



100A Mains Switch Fitted



Tail Clamp Pre-Installed



RCCB Fitted



*Example shown - CUEB18MSRCD12

Terminal Layouts...

14 Way - Neutral & Earth Terminal Configuration



16 Way - Neutral & Earth Terminal Configuration

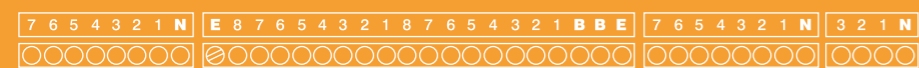

18 Way - Neutral & Earth Terminal Configuration



22 Way - Neutral & Earth Terminal Configuration

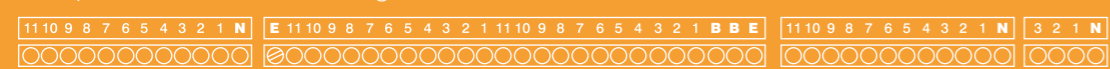

Product SKU	Description	Dimensions (mm)
CUEB14MSRCD8	14 Way Unit with 100A Mains Switch + 2 x 80A 30mA RCCB (4+4 Free Ways)	330 (W) x 260 (H) x 115 (D)
CUEB16MSRCD10	16 Way Unit with 100A Mains Switch + 2 x 80A 30mA RCCB (5+5 Free Ways)	366 (W) x 260 (H) x 115 (D)
CUEB18MSRCD12	18 Way Unit with 100A Mains Switch + 2 x 80A 30mA RCCB (6+6 Free Ways)	402 (W) x 260 (H) x 115 (D)
CUEB22MSRCD16	22 Way Unit with 100A Mains Switch + 2 x 80A 30mA RCCB (8+8 Free Ways)	474 (W) x 260 (H) x 115 (D)



Split Load Units Including Surge Protection

A range of Elucian® Metal Consumer Units furnished with a 100A Mains Switch, 2 x 80A Type A RCCBs and a 2 Pole Type 2 275Uc (V-) 40kA SPD.



Split Load Board



100A Mains Switch Fitted



Tail Clamp Pre-Installed



RCCB Fitted



SPD Fitted



*Example shown - CUEB16MSRCDSP9

Terminal Layouts...

14 Way - Neutral & Earth Terminal Configuration



16 Way - Neutral & Earth Terminal Configuration



18 Way - Neutral & Earth Terminal Configuration



22 Way - Neutral & Earth Terminal Configuration



Product SKU	Description	Dimensions (mm)
CUEB14MSRCDSP6	14 Way Unit with 100A Mains Switch + 2 x 80A 30mA RCCB + 2 Pole SPD (6 Free Ways)	330 (W) x 260 (H) x 115 (D)
CUEB16MSRCDSP9	16 Way Unit with 100A Mains Switch + 2 x 80A 30mA RCCB + 2 Pole SPD (9 Free Ways)	366 (W) x 260 (H) x 115 (D)
CUEB18MSRCDSP11	18 Way Unit with 100A Mains Switch + 2 x 80A 30mA RCCB + 2 Pole SPD (11 Free Ways)	402 (W) x 260 (H) x 115 (D)
CUEB22MSRCDSP15	22 Way Unit with 100A Mains Switch + 2 x 80A 30mA RCCB + 2 Pole SPD (15 Free Ways)	474 (W) x 260 (H) x 115 (D)



Combination Units (High Integrity)

A range of High Integrity Elucian® Metal Consumer Units furnished with a 100A Mains Switch and 2 x 80A Type A RCCBs.



High Integrity Board



Mains Switch Fitted



Tail Clamp Pre-Installed



RCCB Fitted



*Example shown - CUEHIB18MSRCD12

Terminal Layouts...

14 Way - Neutral & Earth Terminal Configuration



16 Way - Neutral & Earth Terminal Configuration



18 Way - Neutral & Earth Terminal Configuration

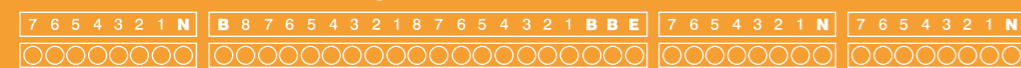

22 Way - Neutral & Earth Terminal Configuration

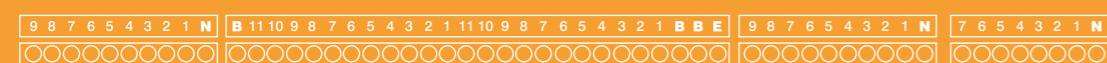

Product SKU	Description	Dimensions (mm)
CUEHIB14MSRCD8	14 Way Unit with 100A Mains Switch + 2 x 80A RCCB (8 Free Ways)	330 (W) x 260 (H) x 115 (D)
CUEHIB16MSRCD10	16 Way Unit with 100A Mains Switch + 2 x 80A RCCB (10 Free Ways)	366 (W) x 260 (H) x 115 (D)
CUEHIB18MSRCD12	18 Way Unit with 100A Mains Switch + 2 x 80A RCCB (12 Free Ways)	402 (W) x 260 (H) x 115 (D)
CUEHIB22MSRCD16	22 Way Unit with 100A Mains Switch + 2 x 80A RCCB (16 Free Ways)	474 (W) x 260 (H) x 115 (D)



Combination Units (High Integrity) Including Surge Protection

A range of High Integrity Elucian® Metal Consumer Units furnished with a 100A Mains Switch, 2 x 80A Type A RCCBs and a 2 Pole Type 2 275Uc (V-) 40kA SPD.



High Integrity Board



Mains Switch Fitted



Tail Clamp Pre-Installed



RCCB Fitted



SPD Fitted



*Example shown - CUEHIB16MSRCDSP9

Terminal Layouts...

14 Way - Neutral & Earth Terminal Configuration



16 Way - Neutral & Earth Terminal Configuration

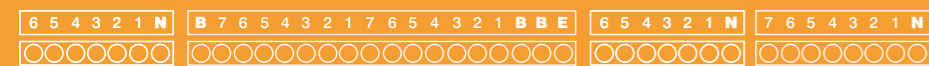

18 Way - Neutral & Earth Terminal Configuration

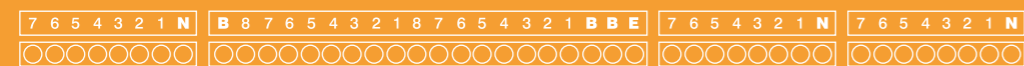

22 Way - Neutral & Earth Terminal Configuration

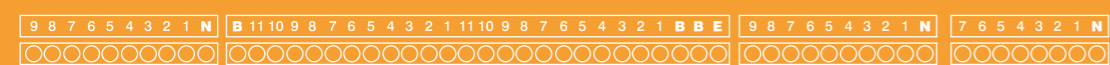

Product SKU	Description	Dimensions (mm)
CUEHIB14MSRCDSP7	14 Way Unit with 100A Mains Switch + 2 x 80A RCCB & SPD (7 Free Ways)	330 (W) x 260 (H) x 115 (D)
CUEHIB16MSRCDSP9	16 Way Unit with 100A Mains Switch + 2 x 80A RCCB & SPD (9 Free Ways)	366 (W) x 260 (H) x 115 (D)
CUEHIB18MSRCDSP11	18 Way Unit with 100A Mains Switch + 2 x 80A RCCB & SPD (11 Free Ways)	402 (W) x 260 (H) x 115 (D)
CUEHIB22MSRCDSP15	22 Way Unit with 100A Mains Switch + 2 x 80A RCCB & SPD (15 Free Ways)	474 (W) x 260 (H) x 115 (D)



Terminal Layouts...

5 Way - Neutral & Earth Terminal Configuration



IP65 Garage Units

The Elucian IP65 Garage Unit is a tough, lockable power solution with IP65 protection and flexible cable entry, ideal for garages and outbuildings.



*Example shown - GUEB5MS3IP65



Tail Clamp
Pre-installed



RCCB Fitted



100A
Mains
Switch Fitted



IP65
Ingress
Protection

Product SKU	Description	Dimensions (mm)
GUEB5IP65	5 Way Unpopulated IP65 Garage Unit - White	195 (W) x 250 (H) x 120 (D)
GUEB5MS3IP65	5 Way IP65 Unit with 100A Main Switch (3 Free Ways) - White	195 (W) x 250 (H) x 120 (D)
GUEB563RCD3IP65	5 Way IP65 Unit with 63A 30mA RCCB (3 Free Ways) - White	195 (W) x 250 (H) x 120 (D)
GUEB5IP65AG	5 Way Unpopulated IP65 Garage Unit - Anthracite Grey	195 (W) x 250 (H) x 120 (D)
GUEB5MS3IP65AG	5 Way IP65 Unit with 100A Main Switch (3 Free Ways) - Anthracite Grey	195 (W) x 250 (H) x 120 (D)
GUEB563RCD3IP65AG	5 Way IP65 Unit with 63A 30mA RCCB (3 Free Ways) - Anthracite Grey	195 (W) x 250 (H) x 120 (D)



Mini Units (Garage)

A range of Elucian® Metal Consumer Units ideal for garage installations.
Furnished with either a 100A Mains Switch, 63A Type A RCCB or 80A Type A RCCB.



Tail Clamp
Pre-Installed



RCCB Fitted



100A
Mains
Switch Fitted



*Example shown - GUEB5MS3

Terminal Layouts...

5 Way - Neutral & Earth Terminal Configuration



Product SKU	Description	Dimensions (mm)
GUEB563RCD3	5 Way Unit with 63A 30mA RCCB (3 Free Ways)	168 (W) x 260 (H) x 115 (D)
GUEB580RCD3	5 Way Unit with 80A 30mA RCCB (3 Free Ways)	168 (W) x 260 (H) x 115 (D)
GUEB5MS3	5 Way Unit with 100A Main Switch (3 Free Ways)	168 (W) x 260 (H) x 115 (D)



Terminal Layouts...

5 Way - Neutral & Earth Terminal Configuration



Electric Vehicle Units

The Elucian range of Electric Vehicle Units combines safety, strength, and convenience, an ideal choice for dependable EV charging.



*Example shown - EV51001

Product SKU	Description	Dimensions (mm)
EV51001	5 Way EV Unit with 100A Mains Switch & 32A B Curve RCBO (2 Free Ways)	168 (W) x 260 (H) x 115 (D)
EV51002	5 Way EV Unit with 100A Mains Switch & 40A B Curve RCBO (2 Free Ways)	168 (W) x 260 (H) x 115 (D)
EV52001	5 Way EV Unit with 100A Mains Switch, SPD & 32A B Curve RCBO (1 Free Way)	168 (W) x 260 (H) x 115 (D)
EV52002	5 Way EV Unit with 100A Mains Switch, SPD & 40A B Curve RCBO (1 Free Way)	168 (W) x 260 (H) x 115 (D)
EV53001	5 Way EV Unit with 63A 30mA Type A RCCB, SPD, 6A B Curve MCB & 16A B Curve MCB	168 (W) x 260 (H) x 115 (D)
EV53002	5 Way EV Unit with 63A 30mA Type A RCCB, SPD & 40A B Curve MCB (1 Free Way)	168 (W) x 260 (H) x 115 (D)
EV54001	5 Way EV Unit with 63A 30mA Type B RCCB & 32A B Curve MCB (1 Free Way)	168 (W) x 260 (H) x 115 (D)
EV54002	5 Way EV Unit with 63A 30mA Type B RCCB & 40A B Curve MCB (1 Free Way)	168 (W) x 260 (H) x 115 (D)



Tail Clamp
Pre-installed



RCCB Fitted



100A
Mains
Switch Fitted



RCBO Fitted



MCB Fitted



SPD Fitted



Terminal Layouts...

5 Way - Neutral & Earth Terminal Configuration



IP65 Electric Vehicle Units

The IP65 rated Elucian EV Units deliver dependable charging performance with complete protection against dust and water, ideal for garages and outbuildings.



*Example shown - EV52001IP65



Tail Clamp
Pre-Installed



RCBO Fitted



100A
Mains
Switch Fitted



SPD Fitted



IP65
Ingress
Protection

Product SKU	Description	Dimensions (mm)
EV52001IP65	5 Way IP65 EV Unit with 100A Mains Switch, SPD & 32A B Curve RCBO (1 Free Way) - White	195 (W) x 250 (H) x 120 (D)
EV52002IP65	5 Way IP65 EV Unit with 100A Mains Switch, SPD & 40A B Curve RCBO (1 Free Way) - White	195 (W) x 250 (H) x 120 (D)
EV53002IP65	5 Way IP65 EV Unit with 63A 30mA Type A RCCB, SPD & 40A B Curve MCB (1 Free Way) - White	195 (W) x 250 (H) x 120 (D)
EV54002IP65	5 Way IP65 EV Unit with 63A 30mA Type B RCCB & 40A B Curve MCB (1 Free Way) - White	195 (W) x 250 (H) x 120 (D)
EV52001IP65AG	5 Way IP65 EV Unit with 100A Mains Switch, SPD & 32A B Curve RCBO (1 Free Way) - Anthracite Grey	195 (W) x 250 (H) x 120 (D)
EV52002IP65AG	5 Way IP65 EV Unit with 100A Mains Switch, SPD & 40A B Curve RCBO (1 Free Way) - Anthracite Grey	195 (W) x 250 (H) x 120 (D)
EV53002IP65AG	5 Way IP65 EV Unit with 63A 30mA Type A RCCB, SPD & 40A B Curve MCB (1 Free Way) - Anthracite Grey	195 (W) x 250 (H) x 120 (D)
EV54002IP65AG	5 Way IP65 EV Unit with 63A 30mA Type B RCCB & 40A B Curve MCB (1 Free Way) - Anthracite Grey	195 (W) x 250 (H) x 120 (D)



RCCB Units

Elucian® RCCB Consumer Units designed for dependable residual current protection and adaptable installation options.



Tail Clamp
Pre-Installed



RCCB Fitted



*Example shown - CUEB663RCD4

Terminal Layouts...

6 Way - Neutral & Earth Terminal Configuration



10 Way - Neutral & Earth Terminal Configuration



Product SKU	Description	Dimensions (mm)
CUEB663RCD4	6 Way Unit with 63A 30mA Type A RCCB (4 Free Ways)	185 (W) x 260 (H) x 115 (D)
CUEB1080RCD8	10 Way Unit with 80A 30mA Type A RCCB (8 Free Ways)	258 (W) x 260 (H) x 115 (D)

Keeping you
in charge...



Functional, stylish,
and innovative.

Protection Devices

Our Elucian® range of Protection Devices are easy to install, suitable for residential and light commercial environments, they provide protection against earth faults to ensure people's safety against electrocution and fires.

Features & Benefits...

Technical Information...

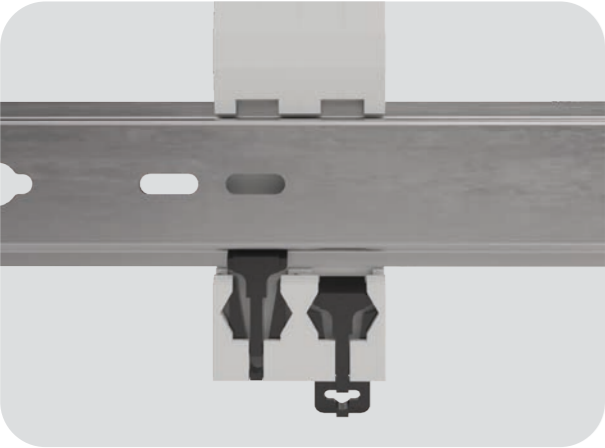

Clip in Devices

The Elucian® Protection Devices simply click onto the DIN Rail and can be secured with this locking mechanism. This means work can be carried out quicker and without dealing with tight spaces.



Lock Off Capabilities

Lockout devices (available at Unicrimp®) are designed to attach to the moving part of the protective device, usually a switch toggle (rocker switch) which moves from the on to off position. This ensures the switch cannot be switched back on while work is being carried out.



Clear Indication

Each protective device has clear and visible trip indication along with clear product information which is easily visible whatever the switch position.



3 Year Product Warranty

We take pride in leading the market and our 3 year warranty offers the best peace of mind available as standard today. It reflects the confidence we have in our products and the benefit of years of continuous engineering improvement.



Visual Status Indicator

Individual cartridge indication; Green: OK; Red: Replace cartridge (Product Ref: CU1SPDC275)



Green Indicator

SPD cartridge is operating correctly.

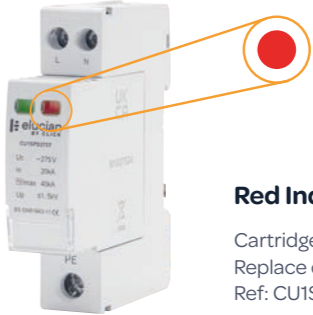

Red Indicator

Cartridge is at end of life. Replace cartridge (Product Ref: CU1SPDC275)

Surge Protection

The Type 2, 2 Pole 40kA Surge Protection Device 275Uc (V-) protect all aspects of the installation from an electrical surge, anything from lighting to lightning.

As well as preventing premature aging, destruction of equipment and unnecessary downtime SPDs protect sensitive electronic equipment connected to the installation such as computers, televisions, washing machines & LED Lighting.

Technical Data

- Complies with BS EN 61643-1-11
- Internal overcurrent protection 300A
- Compatible earthing systems TT & TN

Installation and Connection

- The main protection SPDs are installed directly after the main incoming switch or RCCB.
- Connected in parallel to the equipment to be protected.
- Protection is assured in both common and differential modes.
- Additional overcurrent protection is not required.
- The cartridges are to be removed for insulation resistance testing.

Mains Switch-Disconnecter

2 Pole 100A Mains Isolator Switch.

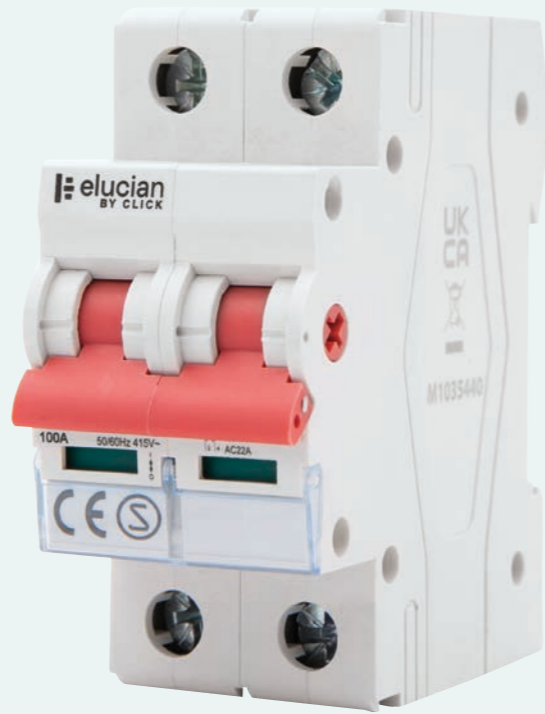

- Double Pole
- 100A Rated
- Large Terminal Capacity
- 3 Year Warranty

CU2MS100
100A 2 Pole Disconnecter-Switch

Type A - RCCBs

- Bi-Directional
- Double Pole
- Type A
- Type S
- Large Terminal Capacity
- 3 Year Warranty



2 Pole 30mA Residual Current Circuit Breaker

CU2RCD63A
63A 30mA 2 Pole RCCB

CU2RCD80A
80A 30mA 2 Pole RCCB

CU2RCD100A
100A 30mA 2 Pole RCCB

Time Delay Residual Current Circuit Breaker

CU2RCDTD63A
63A 100mA 2 Pole Time Delay RCCB

CU2RCDTD80A
80A 100mA 2 Pole Time Delay RCCB

CU2RCDTD100A
100A 100mA 2 Pole Time Delay RCCB

SPDs

2 Pole 40kA Type 2 18mm Surge Protection Device With Tails

- Double Pole
- Response Time <25ns
- Protection Level (UP) <1.5kV
- Max Discharge Current 40kA
- 3 Year Warranty
- Large Terminal Capacity



CU1SPD275T
40kA 275Uc (V-) 2 Pole Type 2 SPD with Tails

Type B - RCCBs

- Bi-Directional
- Double Pole
- Type B
- Large Terminal Capacity
- 3 Year Warranty

2 Pole 30mA Residual Current Circuit Breaker

CU3RCD25B
2 Pole 25A 30mA RCCB - Bi-directional



CU3RCD40B
2 Pole 40A 30mA RCCB - Bi-directional

CU3RCD63B
2 Pole 63A 30mA RCCB - Bi-directional



AFDD + RCBO



1 Pole True 6kA B & C Curve AFDD + RCBO

- B**
B Curve
- C**
C Curve
- A**
Type A
- 30mA**
Trip Current
- 6kA**
True 6kA
- 
Large Terminal Capacity
- 3YR**
3 Year Warranty
- 
1 Pole + Switched Neutral



RCBO Devices

1 Pole + Neutral True 6kA B Curve & C Curve 30mA Trip RCBOs

- 
1 Pole + Neutral
- 30mA**
Trip Current
- 6kA**
True 6kA
- A**
Type A
- 
Large Terminal Capacity
- 3YR**
3 Year Warranty



Type A Single Pole B Curve

CU1RCBO6B
6A 30mA B Curve True 6kA RCBO

CU1RCBO10B
10A 30mA B Curve True 6kA RCBO

CU1RCBO16B
16A 30mA B Curve True 6kA RCBO

CU1RCBO20B
20A 30mA B Curve True 6kA RCBO

CU1RCBO25B
25A 30mA B Curve True 6kA RCBO

CU1RCBO32B
32A 30mA B Curve True 6kA RCBO

CU1RCBO40B
40A 30mA B Curve True 6kA RCBO

Type A Single Pole C Curve

CU1RCBO6C
6A 30mA C Curve True 6kA RCBO

CU1RCBO10C
10A 30mA C Curve True 6kA RCBO

CU1RCBO16C
16A 30mA C Curve True 6kA RCBO

CU1RCBO20C
20A 30mA C Curve True 6kA RCBO

CU1RCBO25C
25A 30mA C Curve True 6kA RCBO

CU1RCBO32C
32A 30mA C Curve True 6kA RCBO

CU1RCBO40C
40A 30mA C Curve True 6kA RCBO

Type B Curve AFDD & RCBO

- CU1AFDD6B**
1 Pole True 6kA B Curve 6A AFDD & RCBO 30mA
- CU1AFDD10B**
1 Pole True 6kA B Curve 10A AFDD & RCBO 30mA
- CU1AFDD16B**
1 Pole True 6kA B Curve 16A AFDD & RCBO 30mA
- CU1AFDD20B**
1 Pole True 6kA B Curve 20A AFDD & RCBO 30mA
- CU1AFDD25B**
1 Pole True 6kA B Curve 25A AFDD & RCBO 30mA
- CU1AFDD32B**
1 Pole True 6kA B Curve 32A AFDD & RCBO 30mA
- CU1AFDD40B**
1 Pole True 6kA B Curve 40A AFDD & RCBO 30mA

Type C Curve AFDD & RCBO

- CU1AFDD6C**
1 Pole True 6kA C Curve 6A AFDD & RCBO 30mA
- CU1AFDD10C**
1 Pole True 6kA C Curve 10A AFDD & RCBO 30mA
- CU1AFDD16C**
1 Pole True 6kA C Curve 16A AFDD & RCBO 30mA
- CU1AFDD20C**
1 Pole True 6kA C Curve 20A AFDD & RCBO 30mA
- CU1AFDD25C**
1 Pole True 6kA C Curve 25A AFDD & RCBO 30mA
- CU1AFDD32C**
1 Pole True 6kA C Curve 32A AFDD & RCBO 30mA
- CU1AFDD40C**
1 Pole True 6kA C Curve 40A AFDD & RCBO 30mA

Bi-Directional RCBO Devices

1 Pole + Switched Neutral True 6kA B Curve
& C Curve Bi-Directional 30mA Trip RCBOs

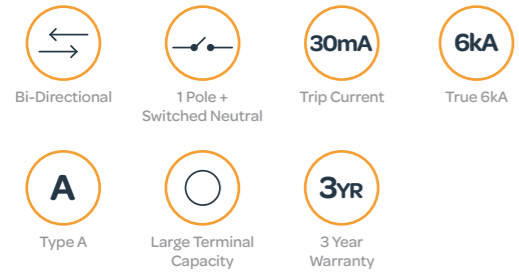

*Example shown - CU1RCBOD6B Single Pole Switched Neutral B Curve Bi-Directional

RCBO Devices

Double Pole 2 Module True 6kA B Curve
& C Curve 30mA Trip RCBOs

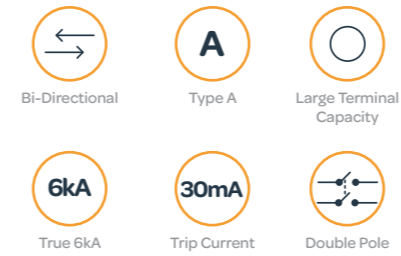

*Example shown - CU2RCBO45B

Type A Single Pole with Switched Neutral B Curve Bi-Directional

CU1RCBOD6B
6A 30mA B Curve Bi-Directional True 6kA RCBO

CU1RCBOD10B
10A 30mA B Curve Bi-Directional True 6kA RCBO

CU1RCBOD16B
16A 30mA B Curve Bi-Directional True 6kA RCBO

CU1RCBOD20B
20A 30mA B Curve Bi-Directional True 6kA RCBO

CU1RCBOD25B
25A 30mA B Curve Bi-Directional True 6kA RCBO

CU1RCBOD32B
32A 30mA B Curve Bi-Directional True 6kA RCBO

CU1RCBOD40B
40A 30mA B Curve Bi-Directional True 6kA RCBO

CU1RCBOD45B
45A 30mA B Curve Bi-Directional True 6kA RCBO

Type A Single Pole with Switched Neutral C Curve Bi-Directional

CU1RCBOD6C
6A 30mA C Curve Bi-Directional True 6kA RCBO

CU1RCBOD10C
10A 30mA C Curve Bi-Directional True 6kA RCBO

CU1RCBOD16C
16A 30mA C Curve Bi-Directional True 6kA RCBO

CU1RCBOD20C
20A 30mA C Curve Bi-Directional True 6kA RCBO

CU1RCBOD25C
25A 30mA C Curve Bi-Directional True 6kA RCBO

CU1RCBOD32C
32A 30mA C Curve Bi-Directional True 6kA RCBO

CU1RCBOD40C
40A 30mA C Curve Bi-Directional True 6kA RCBO

CU1RCBOD45C
45A 30mA C Curve Bi-Directional True 6kA RCBO

Type A 2 Module Double Pole B Curve

CU2RCBO45B
45A 30mA B Curve True 6kA RCBO

CU2RCBO50B
50A 30mA B Curve True 6kA RCBO

CU2RCBO63B
63A 30mA B Curve True 6kA RCBO

Type A 2 Module Double Pole C Curve

CU2RCBO45C
45A 30mA C Curve True 6kA RCBO





CU2RCBO50C
50A 30mA C Curve True 6kA RCBO

CU2RCBO63C
63A 30mA C Curve True 6kA RCBO

MCBs Single Pole

1 Pole, True 6kA B Curve & C Curve MCB Devices.







-  B Curve
-  C Curve
-  Single Pole
-  True 6kA
-  Large Terminal Capacity
-  3 Year Warranty

Contactors Devices

20A, 25A, 40A or 63A Modular Contactors



-  3 Year Warranty
-  Normally Open
-  Large Terminal Capacity
-  Normally Closed

Type B Curve

- CU1MCB6B**
6A B Curve True 6kA MCB
- CU1MCB10B**
10A B Curve True 6kA MCB
- CU1MCB16B**
16A B Curve True 6kA MCB
- CU1MCB20B**
20A B Curve True 6kA MCB
- CU1MCB25B**
25A B Curve True 6kA MCB
- CU1MCB32B**
32A B Curve True 6kA MCB
- CU1MCB40B**
40A B Curve True 6kA MCB
- CU1MCB50B**
50A B Curve True 6kA MCB
- CU1MCB63B**
63A B Curve True 6kA MCB

Type C Curve

- CU1MCB6C**
6A C Curve True 6kA MCB
- CU1MCB10C**
10A C Curve True 6kA MCB
- CU1MCB16C**
16A C Curve True 6kA MCB
- CU1MCB20C**
20A C Curve True 6kA MCB
- CU1MCB25C**
25A C Curve True 6kA MCB
- CU1MCB32C**
32A C Curve True 6kA MCB
- CU1MCB40C**
40A C Curve True 6kA MCB
- CU1MCB50C**
50A C Curve True 6kA MCB
- CU1MCB63C**
63A C Curve True 6kA MCB

2 Pole 20A Modular Contactors (1 Module)

- MC20220**
2 Pole 1 Module 20A Contactor, 2 x Normally Open Contacts
- MC20202**
2 Pole 1 Module 20A Contactor, 2 x Normally Closed Contacts
- MC20211**
2 Pole 1 Module 20A Contactor, 1 x Normally Open, 1 x Normally Closed Contacts

4 Pole 25A Modular Contactors (2 Module)

- MC25440**
4 Pole 2 Module 25A Contactor, 4 x Normally Open Contacts
- MC25404**
4 Pole 2 Module 25A Contactor, 4 x Normally Closed Contacts
- MC25422**
4 Pole 2 Module 25A Contactor, 2 x Normally Open, 2 x Normally Closed Contacts
- MC25431**
4 Pole 2 Module 25A Contactor, 3 x Normally Open, 1 x Normally Closed Contacts

4 Pole 40A Modular Contactors (3 Module)

- MC40440**
4 Pole 3 Module 40A Contactor, 4 x Normally Open Contacts
- MC40404**
4 Pole 3 Module 40A Contactor, 4 x Normally Closed Contacts
- MC40422**
4 Pole 3 Module 40A Contactor, 2 x Normally Open, 2 x Normally Closed Contacts
- MC40431**
4 Pole 3 Module 40A Contactor, 3 x Normally Open, 1 x Normally Closed Contacts

4 Pole 63A Modular Contactors (3 Module)

- MC63440**
4 Pole 3 Module 63A Contactor, 4 x Normally Open Contacts
- MC63404**
4 Pole 3 Module 63A Contactor, 4 x Normally Closed Contacts
- MC63422**
4 Pole 3 Module 63A Contactor, 2 x Normally Open, 2 x Normally Closed Contacts
- MC63431**
4 Pole 3 Module 63A Contactor, 3 x Normally Open, 1 x Normally Closed Contacts

Connection Unit

2 Pole 100A Connection Unit

- 100A**
100A Rated
- Large Terminal Capacity**
- 3YR**
3 Year Warranty



CU2CN100
100A 2 Pole Connection Unit

Energy Meters

45A & 100A Multifunction Meters

- 100A**
100A Rated
- 3YR**
3 Year Warranty



CU1EMID
45A Single Phase MID Energy Meter

CU2EMID
100A Single Phase Modbus Multifunction Energy Meter

Fused Main Switch

80A & 100A Fused Main Switches

- 80A**
HRC Fuse Supplied

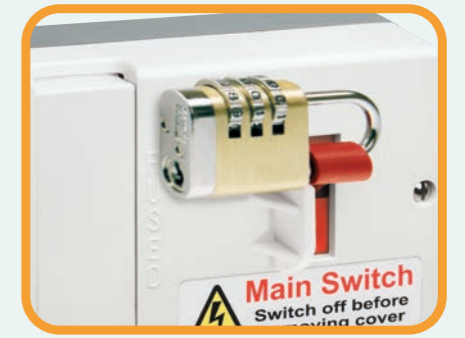

*Padlock not supplied.

Available in...

DB700
80A Fused Main Switch (80A HRC Fuse Fitted)

DB701
80A Fused Main Switch (80A HRC Fuse Fitted) - Lockable

DB750
100A Fused Main Switch (80A HRC Fuse Fitted)

DB751
100A Fused Main Switch (80A HRC Fuse Fitted) - Lockable



Blank Modules

Single way Din Rail Blank Module.

- 3YR**
3 Year Warranty

CU1BLANK
Single Way Din Rail Blank Module



Fused Main Switch Accessories

Product SKU	Description
-------------	-------------

DB981	Elongated Cable Shroud (Packaged Individually) *Enables surface and rear entry cable access *Suitable for 35mm ² cables
--------------	--



Terminal Bars

Product SKU	Description
-------------	-------------

CUTB4	4 Way Terminal Bar
CUTB6	6 Way Terminal Bar
CUTB7	7 Way Terminal Bar
CUTB8	8 Way Terminal Bar
CUTB9	9 Way Terminal Bar
CUTB10	10 Way Terminal Bar
CUTB12	12 Way Terminal Bar
CUTB15	15 Way Terminal Bar
CUTB16	16 Way Terminal Bar
CUTB17	17 Way Terminal Bar
CUTB18	18 Way Terminal Bar
CUTB19	19 Way Terminal Bar
CUTB20	20 Way Terminal Bar
CUTB22	22 Way Terminal Bar
CUTB23	23 Way Terminal Bar
CUTB26	26 Way Terminal Bar
CUTBSC	Terminal Bar Support Clip & Screws (PK5)
CUTBSCSL	Split Load Terminal Bar Support Clip & Screws (PK 5)



Busbar & Cover Sets

Product SKU	Description
-------------	-------------

CUBUS3	3 Way Busbar & Cover Set
CUBUS4	4 Way Busbar & Cover Set
CUBUS5	5 Way Busbar & Cover Set
CUBUS6	6 Way Busbar & Cover Set
CUBUS7	7 Way Busbar & Cover Set
CUBUS8	8 Way Busbar & Cover Set
CUBUS12	12 Way Busbar & Cover Set
CUBUS20	20 Way Busbar & Cover Set
CUCAP	Busbar Caps (PK 10)

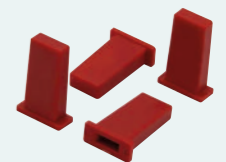
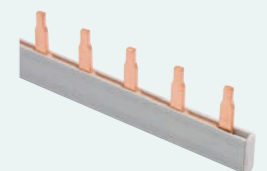
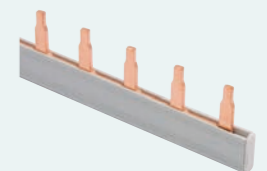

DIN Rails

Product SKU	Description
-------------	-------------

CUDR10	10 Way DIN Rail
CUDR12	12 Way DIN Rail
CUDR14	14 Way DIN Rail
CUDR16	16 Way DIN Rail
CUDR18	18 Way DIN Rail
CUDR22	22 Way DIN Rail

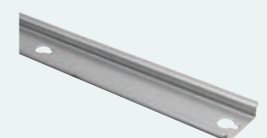

SPD Cartridge

Product SKU	Description
CU1SPDC275	18mm 275V- 40kA SPD Cartridge
CU2SPDC275	36mm 275V- 40kA SPD Cartridge <small>*Replacement for both live and neutral sides</small>



Link Cables

Product SKU	Description
CUCNL210	Neutral Link Cable (210mm)
CUCNL285	Neutral Link Cable (285mm)
CUCNL325	Neutral Link Cable (325mm)
CUCNL385	Neutral Link Cable (385mm)
CUCNL410	Neutral Link Cable (410mm)
CUCLL	Combined Live Link Cable (285mm & 355mm)



Grommet Strip

Product SKU	Description
CUGS1	500mm Grommet Strip (PK 3)



Mains Cable Clamp Components

Product SKU	Description
CUCLAMP	Mains Cable Clamp & Screw
CUPLATE	Mains Cable Clamp Plate



Retrofit Locking Device

Product SKU	Description
CUELOCK	Retrofit Locking Device

*Can be installed on the left or right of the enclosure.
*Padlock not supplied.
UK Patent: GB 2115573.4, Irish Patent: 87573



Adhesive Labels

Product SKU	Description
CULAB1	Set of Adhesive Labels



Premium Lockable Covers

Product SKU	Description
GUEB5PL	5 Way Lockable Front Cover *For use with garage units
CUEB8PL	8 Way Lockable Front Cover
CUEB10PL	10 Way Lockable Front Cover
CUEB12PL	12 Way Lockable Front Cover
CUEB14PL	14 Way Lockable Front Cover
CUEB16PL	16 Way Lockable Front Cover
CUEB18PL	18 Way Lockable Front Cover
CUEB22PL	22 Way Lockable Front Cover



*Lockable lid installed on consumer unit

Flush Lid

Product SKU	Description
CUEB16FL	Flush Lid (16 Way Consumer Units)
CUEB18FL	Flush Lid (18 Way Consumer Units)
CUEB22FL	Flush Lid (22 Way Consumer Units)



Pattress Mount

Product SKU	Description
CUEBPM	Consumer Unit Pattress Mount

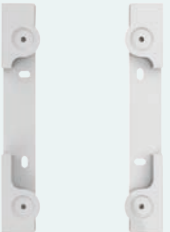

Recess Frames

Product SKU	Description
CUEBRF16	16 Way Consumer Unit Recessed Frame
CUEBRF18	18 Way Consumer Unit Recessed Frame
CUEBRF22	22 Way Consumer Unit Recessed Frame

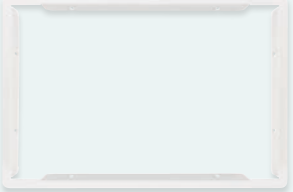

Cable Entry Plate

Product SKU	Description
CUCEPL	Knockout Cable Entry Plate - Large (PK 5)
CUCEPS	Knockout Cable Entry Plate - Small (PK 5)

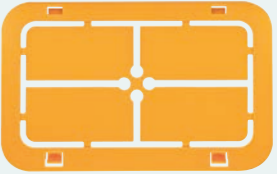

Complete the installation...

We've Got You Covered

The Unicrimp® range includes cable ties, crimp terminals, PVC tape, copper tube terminals, cable clips, brass/nylon glands, tail glands and earth sleeving – providing everything required to harness cable between the consumer unit and the end accessory.

Helps to provide compliance with Regulation 522.8.5.



UNICRIMP

The No.1 Sealant & Adhesives

The No.1 hybrid sealant and adhesive. OB1 bonds and seals a range of materials, works in damp conditions and even under water. User-friendly, hybrid polymer formulation for the ultimate in bonding and sealing.



OB1 MULTI-SURFACE CONSTRUCTION SEALANT & ADHESIVE

Cable & Wire Accessories.

Explore our extensive range of cable management consumables. All our products are manufactured under stringent quality control systems and are fully compliant with the very latest industry regulations.



Q-CRIMP

Fire-Rated Accessories

Don't get caught out by the latest regs! Explore our range of fire rated products and prevent cables from premature collapse during a fire and keep emergency services and the public safe.

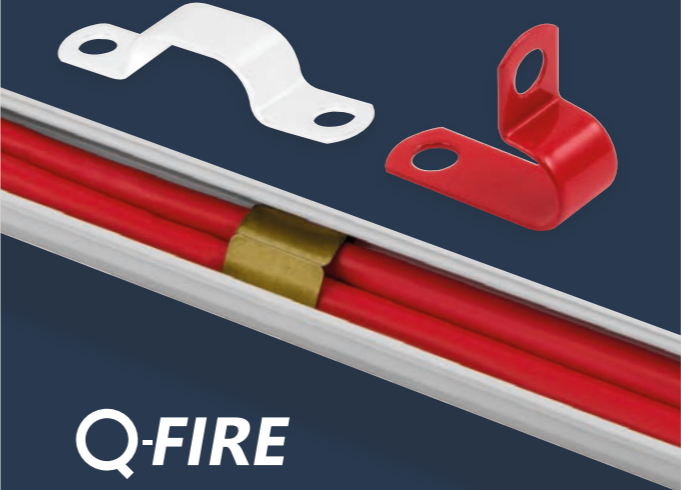

Q-FIRE

Lever Connectors & Connection Boxes

Focusing on strong, quick and reliable solutions, the new Q-Nect range offers great versatility for electrical connections. Each product is packed with features which makes your installations quicker and easier.



Q-NECT

Complete the installation...

Bluetooth DIN Rail Time Switches

Bluetooth is a wireless communication protocol that allows programming of the switch using the free APP available on Android and IOS smart phones and tablets. This works the same way as bluetooth headphones and speakers. The program is setup on the APP and transfers to the switch when the smart device is held in close proximity.

NFC DIN Rail Time Switches

NFC (Near Field Communication) is a wireless communication protocol that allows you to program the switch using the free Sangamo Connect app on an Android NFC Smart phone.

This works the same way as contactless bank cards, oyster travel cards and mobile payment systems. You set the program up on the app and hold the phone next to the switch to read, write or transfer programming times.

DIN Rail Time Switches

All Sangamo's DIN Rail mountable time switches are designed for 35mm "Top Hat" rail. Switches come in 1, 2 or 4 modules, each module is 17.5mm wide, which fits the required width in the DIN enclosure.

Using the 25195 USB Hub and Easy Vue software or 25196 USB Hub with bluetooth and connect app programs can be transferred to a 25193 data key and then to one or multiple switches. 1 module switches do not require a Data Key as the fascia can be removed and slotted into the Hub directly.



NFC DIN Rail Time Switches



72113NFC

Standard NFC 2 Module 1 Channel, 7 Day, 56 Operations

72102NFC

Astro NFC Module 1 Channel, 24HR Timer, 4 Operations

72103NFC

Astro NFC 2 Module 1 Channel, 7 Day, 56 Operations

Bluetooth DIN Rail Time Switches



SC2811PRO4

Standard Bluetooth 2 Module 1 Channel, 7 Day, 100 Operations

SC2813PRO4

Astro Bluetooth 2 Module 1 Channel, 7 Day, 100 Operations

SC2823PRO4

Astro Bluetooth 2 Module 2 Channel, 7 Day, 100 Operations

DIN Rail Time Switches



71111

Standard 1 Module 1 Channel, 7 Day, 46 Operations

72112

Standard 2 Module 1 Channel, 7 Day, 46 Operations

25162

Standard 2 Module 1 Channel, Yearly, 300 Operations

26404

Standard 4 Module 4 Channel, 7 Day, 300 Operations

11002

Standard 1 Module 24HR Timer

71101

Astro 1 Module 1 Channel, 7 Day, 60 Operations

72101

Astro 2 Module 1 Channel, 7 Day, 60 Operations

72201

Astro 2 Module 2 Channel, 7 Day, 60 Operations

Three Phase Distribution Boards and Circuit Protection Devices.

Three Phase Brochure

Check out our Three Phase Distribution brochure and explore our huge range of Metal Distribution Boards, Circuit Protection Devices and accessories.



*Scan the QR code to view our Three Phase brochure.



Metal Distribution Boards.

Elucian® offers a versatile range of Three Phase Metal Distribution Boards designed to suit a wide variety of installations, these boards are packed with features that enhance convenience, flexibility, and safety.

- 125A Incomer 4 & 6 Way Boards
- 125A or 250A Incomer 8, 12, 16, 20 & 24 Way Boards



elucianuk.com



Circuit Protection Devices.

Our Elucian® range of Protection Devices are easy to install, suitable for commercial and industrial environments, they provide protection against earth faults to ensure people's safety against electrocution and fires.

Main Incomers

- Mains Isolator Switch
- RCCBs (Type A & B)
- Fused Main Switch

Protection Devices

- RCBO (B & C Curve)
- AFDD (B & C Curve)
- AFDD + MCB
- 1 & 3 Pole MCBs
- SPD & Cartridges
- Energy Meter Kits
- Blank Modules

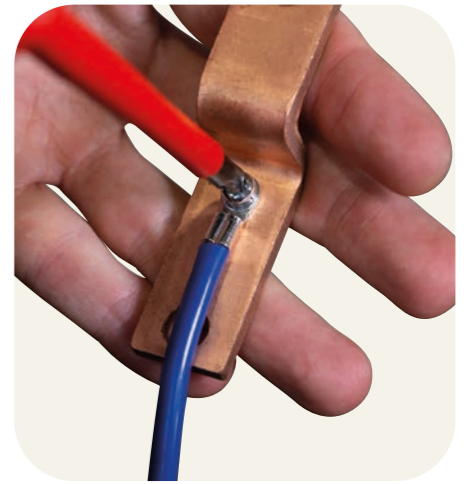

Spares & Accessories.

The Elucian® range offers a wide variety of compatible accessories, including cable entry plates and pattress mounts, to make any installation easier and faster.

- Extension Boards
- Three Phase to Single Phase Converter
- Isolator Locking Kit
- RCD Link Kit
- Gland Plates
- Blank Plates
- Busbar Caps
- Synthetic Bonded Resin Paper
- Label Packs



More from the Scolmore® Group.

Wiring Accessories.

Click Scolmore® is one of the UK's leading manufacturers of electrical accessories. The company is proud to be a British-based, family-run business with an international reputation for quality, innovation and exemplary customer service.



Lighting Solutions.

The comprehensive collection of lighting products from Ovia® will provide solutions for a whole spectrum of projects in a broad variety of sectors, including domestic, commercial, industrial, utility, amenity, emergency lighting and floodlighting.



Cable & Wiring Accessories.

Unicrimp offers a comprehensive range of cable accessories under the Q-crimp, Q-Fire, and Q-Nect brands, exclusively for the electrical trade. All products meet strict quality standards and comply with the latest regulations.



- Cable Ties
- Crimp Terminals
- PVC Tape
- Copper Tube Terminals
- Cable Clips
- Brass & Nylon Glands
- Tail Glands
- Earth Sleeving

Helps to provide compliance with Regulation 522.8.5.



Fire & Security Products.

ESP is a leading supplier of electronic security and fire protection products, including Smart Security, CCTV, Access Control, Fire Protection, Emergency Lighting, and Sangamo Time Switches and Heating Controls.



No.1 Sealant and Adhesives.

The No.1 hybrid sealant and adhesive. OB1 bonds and seals a range of materials, works in damp conditions and even under water. User-friendly, hybrid polymer formulation for the ultimate in bonding and sealing.



United Kingdom



Scolmore House, Mariner,
Lichfield Road Industrial Estate
Tamworth, Staffordshire, B79 7UL

+44 (0) 1827 63454
sales@scolmore.com
www.scolmore.com



Southern Ireland



18 Corrig Road,
Sandyford Industrial Estate,
Dublin, D18 WV79, Ireland

+353 (1) 2811 122
sales@clicklitehouse.ie
www.clicklitehouse.ie



Scolmore[®] Middle East



Lake Central Tower,
Office 1803, Business Bay,
Dubai, UAE

+971 4589 6552
sales@scolmoreme.com
www.scolmoreme.com

